

FITTING INSTRUCTION

Clamp mark in acc. with		Cables joining
ISO	PN	
1	L	Left directional lights
2	+	Rear fog lights
3	31	Ground
4	R	Right directional lights
5	58R	Right side parking lights
6	54	Stoptlights
7	58L	Left side parking lights

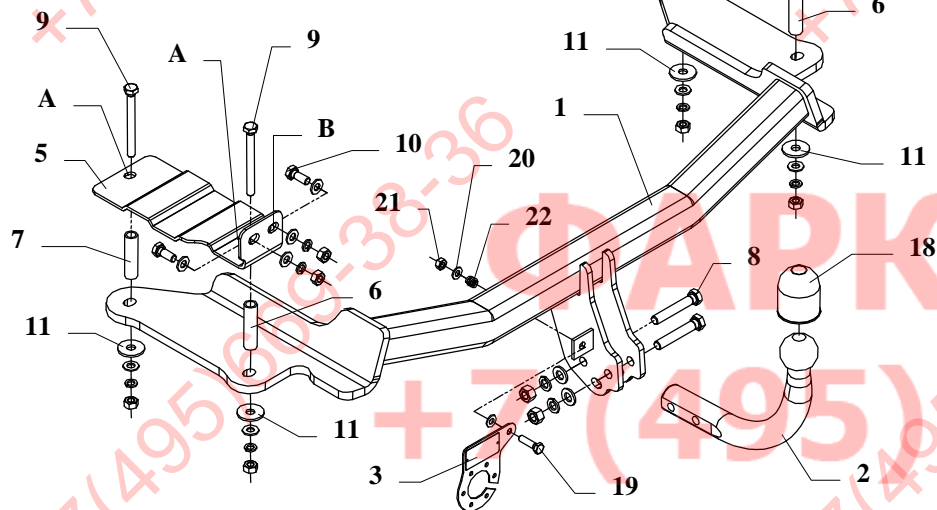

This towbar is designed to assembly in following car:
OPEL VECTRA "C", 4/5 door, produced since 06.2002 till 2008,
 catalogue no. **E40** and is prepared to tow trailers max total weight **1950 kg**
 and max vertical load **78 kg**.

From manufacturer

Thank you for buying our product. Their reliability has been confirmed in many tests. Reliability of towbar depends also on correct assembly and right operation. For this reasons we kindly ask to read carefully this instruction and apply to hints.

The towbar should be install in points described by a car producer.

The instruction of the assembly

1. Disassemble the bumper.
2. Drill the original two holes (pos. A) on the left and right side inside the trunk and drill two holes per each side in the rear panel (pos. B) - use bit $\varnothing 17,5\text{mm}$.
3. Position the distance sleeves (pos. 6 and 7) and fish-plates (pos. 4 and 5) - see the drawing.
4. Position the main bar of the towbar (pos. 1) at the bottom of the car and fix it through the holes (pos. A), distance sleeves and fish-plates (pos. 4 and 5) using bolts M10x100mm (pos. 9); then fix it through the holes (pos. B) and fishplates (pos. 4 and 5) using bolts M10x25mm (pos. 10).
5. Reassemble the bumper.
6. Position the ball of towbar (pos. 2) and fix with M12x70mm bolts (pos. 8) from the towbar accessories.
7. Fix the socket plate (pos. 3) as shown on the drawing.
8. Tighten all nuts and bolts according to the torque shown in the table.
9. Connect electric wires of 7-poles socket according to the instruction of the car. (Recommend to make at authorized service station).
10. Complete the paint cover of towbar (during the mounting paint cover could be destroyed).

Torque settings for nuts and bolts (8,8):	
M 8 - 25 Nm	M 10 - 55 Nm
M 12 - 85 Nm	M 14 - 135 Nm











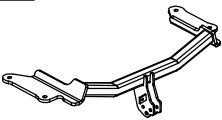



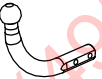



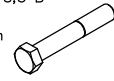

NOTE

After install the towbar you should get adequate note in registration book (at authorised service station).The car should be equipped with:

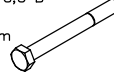
- Indicators
- Tow mirrors

After 1000km of exploitation check all bolts and nuts. The ball of towbar must be always kept clear and conserve with a grease.

Towbar accessories:

Pos. 1 Name: Main bar Quantity: 1 	Pos. 5 Name: Left fish-plate Quantity: 1 	Pos. 11 Name: Washer Quantity: 4 Dim.: $\phi 35 \times \phi 12 \times 3 \text{ mm}$ 	Pos. 17 Name: Spring washer Quantity: 8 Dim.: $\phi 10,2 \text{ mm}$ 
Pos. 2 Name: Tow ball Quantity: 1 	Pos. 6 Name: Distance sleeve Quantity: 2 Dim.: $\phi 17,2 \times \phi 12 \text{ mm}$ L=66mm 	Pos. 12 Name: Nut 8 B Quantity: 2 Dim.: M12 	Pos. 18 Name: Ball cover Quantity: 1 
Pos. 3 Name: Socket plate Quantity: 1 	Pos. 7 Name: Distance sleeve Quantity: 2 Dim.: $\phi 17,2 \times \phi 12 \text{ mm}$ L=64mm 	Pos. 13 Name: Nut 8 B Quantity: 8 Dim.: M10 	Pos. 19 Name: Bolt 8,8 B Quantity: 1 Dim.: M8x30mm 
Pos. 4 Name: Right fish-plate Quantity: 1 	Pos. 8 Name: Bolt 8,8 B Quantity: 2 Dim.: M12x70mm 	Pos. 14 Name: Plain washer Quantity: 2 Dim.: $\phi 13 \text{ mm}$ 	Pos. 20 Name: Plain washer Quantity: 2 Dim.: $\phi 8,5 \text{ mm}$ 
	Pos. 9 Name: Bolt 8,8 B Quantity: 4 Dim.: M10x100mm 	Pos. 15 Name: Plain washer Quantity: 12 Dim.: $\phi 10,5 \text{ mm}$ 	Pos. 21 Name: Nut 8 B Quantity: 1 Dim.: M8 
	Pos. 10 Name: Bolt 8,8 B Quantity: 4 Dim.: M10x25mm 	Pos. 16 Name: Spring washer Quantity: 2 Dim.: $\phi 12,2 \text{ mm}$ 	Pos. 22 Name: Spring Quantity: 1 



PPUH AUTO-HAK S.J.

Produkcja Zaczepów Kulowych
Henryk & Zbigniew Nejman
76-200 SŁUPSK ul. Słoneczna 16K
tel/fax (059) 8-414-414; 8-414-413
E-mail: office@autohak.com.pl
www.autohak.com.pl

Towing hitch (without electrical set)

Class: **A50-X** Cat. no. **E40**

Designed for:

Manufacturer: **OPEL**

Model: **VECTRA "C"**

Type: **4/5 door**

produced since 06.2002 till 2008

Approval number acc. to regulations EKG/ONZ 55.01: **E20-55R-01 0801**

Technical data:

D-value: 9,82 kN

maximum trailer weight: **1950 kg**

maximum vertical cup load: **78 kg**

Foreword

This towbar is designed according to rules of safety traffic regulations. The towing hitch is a safety component and can be install only by qualified personnel. Any alteration or conversion of the towing hitch is prohibited and would lead to cancellation of design certification. Remove insulating compound and underseal from vehicle (if present) in the area of the matting surfaces of the towing hitch.

The vehicle manufacturer's specifications regarding trailer load and max. vertical cup load are decisive for driving whereat values for the towing hitch cannot be exceeded.

D-value formula:

$$\frac{\text{Max trailer weight [kg]} \times \text{Max vehicle weight [kg]}}{\text{Max trailer weight [kg]} + \text{Max vehicle weight [kg]}} \times \frac{9,81}{1000} = D \text{ [kN]}$$